

FRA-RFM

RETURN FILTERS



MATERIALS

Head and cover : Aluminium alloy

Bowl :

Polyamide for FRA21-31-32-33-41

Zinc plated steel for FRA11-42-51-52- 53-5D

Bypass valve: Polyamide

Seals: NBR Nitrile

FKM Fluoroelastomer on request

Indicator housing: Brass

PRESSURE

Max. working: 300 kPa (3 bar)

Collapse, differential for the filter element (ISO 2941): 300 kPa (3 bar)

BYPASS VALVE

Setting: 170 kPa (1,7 bar) \pm 10%

WORKING TEMPERATURE

From -25° to +110° C

COMPATIBILITY (ISO 2943)

Full with fluids: HH-HL-HM-HV-HTG

(according to ISO 6743/4)

For fluids different than the above mentioned,
please contact our Customer Service.

HYDRAULIC DIAGRAM

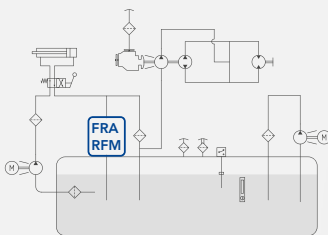

Is this datasheet the latest release? Please check on our website.



FRA

RETURN FILTERS

ORDERING AND OPTION CHART

F	R	A	COMPLETE FILTER FAMILY														FILTER ELEMENT FAMILY	E	R	A	
			SIZE & LENGHT	11	21	31	32	33	41	42	51	5A	52	5B	5C	53	5D	SIZE & LENGHT			
			PORT TYPE																		
			B = BSP thread	B	B	B	B	B	B	B	B	B	B	B	B	B	B				
			N = NPT thread	N	N	N	N	N	N	N	N	N	N	N	N	N					
			S = SAE thread	-	S	S	S	S	S	S	S	S	S	S	S	S					
			F = SAE flange 3000 psi	-	-	-	-	-	-	-	F	F	F	F	F	F					
			PORT SIZE																		
			03 = 3/8"	03	-	-	-	-	-	-	-	-	-	-	-	-					
			04 = 1/2"	-	04	04	-	-	-	-	-	-	-	-	-	-					
			06 = 3/4"	-	-	06	06	06	-	-	-	-	-	-	-	-					
			08 = 1"	-	-	-	08	08	08	08	-	-	-	-	-	-					
			10 = 1" 1/4 (F10 not available)	-	-	-	-	-	10	10	10	10	10	-	-	-					
			12 = 1" 1/2 (** F12 available only for FRA4+ only)	-	-	-	-	-	(*)	(*)	12	12	12	-	-	-					
			16 = 2" (F16 not available)	-	-	-	-	-	-	-	16	16	16	16	16	16					
			20 = 2" 1/2 (F20 only)	-	-	-	-	-	-	-	20	20	20	20	20	20					
			BYPASS VALVE																		
			B = 170 kPa (1,7 bar)	X	B	B	B	B	B	B	B	B	B	B	B	B					
			SEALS														SEALS				
			N = NBR Nitrile	N	N	N	N	N	N	N	N	N	N	N	N	N					
			F = FKM Fluoroelastomer	F	F	F	F	F	F	F	F	F	F	F	F	F					
			FILTER MEDIA														FILTER MEDIA				
			FA = fibreglass 5 µm(c) β>1.000	FA	FA	FA	FA	FA	FA	FA	FA	FA	FA	FA	FA	FA					
			FB = fibreglass 7 µm(c) β>1.000	FB	FB	FB	FB	FB	FB	FB	FB	FB	FB	FB	FB	FB					
			FC = fibreglass 12 µm(c) β>1.000	FC	FC	FC	FC	FC	FC	FC	FC	FC	FC	FC	FC	FC					
			FD = fibreglass 21 µm(c) β>1.000	FD	FD	FD	FD	FD	FD	FD	FD	FD	FD	FD	FD	FD					
			CC = impregnated cellulose 10 µm β>2	CC	CC	CC	CC	CC	CC	CC	CC	CC	CC	CC	CC	CC					
			CD = impregnated cellulose 25 µm β>2	CD	CD	CD	CD	CD	CD	CD	CD	CD	CD	CD	CD	CD					
			ME = wire mesh 60 µm	ME	ME	ME	ME	ME	ME	ME	ME	ME	ME	ME	ME	ME					
			CLOGGING INDICATOR																		
			01 = 1/8" port, plugged	01	01	01	01	01	01	01	01	01	01	01	01	01					
			30 = pressure gauge, rear connection	30	30	30	30	30	30	30	30	30	30	30	30	30					
			32 = pressure gauge, bottom connection	32	32	32	32	32	32	32	32	32	32	32	32	32					
			P1 = SPDT pressure switch	P1	P1	P1	P1	P1	P1	P1	P1	P1	P1	P1	P1	P1					
			ACCESSORIES																		
			W = without	W	W	W	W	W	W	W	W	W	W	W	W	W					
			P = with filling plug	P	P	P	P	P	P	P	P	P	P	P	P	P					
			ACCESSORIES																		
			X= no other accessory available	X	X	X	X	X	X	X	X	X	X	X	X	X					



RFM

RETURN FILTERS

ORDERING AND OPTION CHART

R	F	M	COMPLETE FILTER FAMILY																	FILTER ELEMENT FAMILY	C	R	E		
			SIZE & LENGHT	004	008	012	015	020	025	030	040	050	055	060	070	080	100	110	125	150	160				
				004	008	015	015	025	025	030	050	050	055	060	060	080	100	110	125	150	160	SIZE & LENGHT			
			FILTER MEDIA																	FILTER MEDIA					
			FT = fibreglass 5 µm(c) β>1.000	FT	FT	FT	FT	FT	FT	FT	FT	FT	FT	FT	FT	FT	FT	FT	FT	FT	FT				
			FC = fibreglass 7 µm(c) β>1.000	FC	FC	FC	FC	FC	FC	FC	FC	FC	FC	FC	FC	FC	FC	FC	FC	FC	FC				
			FD = fibreglass 12 µm(c) β>1.000	FD	FD	FD	FD	FD	FD	FD	FD	FD	FD	FD	FD	FD	FD	FD	FD	FD	FD				
			FV = fibreglass 21 µm(c) β>1.000	FV	FV	FV	FV	FV	FV	FV	FV	FV	FV	FV	FV	FV	FV	FV	FV	FV	FV				
			CD = impregnated cellulose 10 µm β>2	CD	CD	CD	CD	CD	CD	CD	CD	CD	CD	CD	CD	CD	CD	CD	CD	CD	CD				
			CV = impregnated cellulose 25 µm β>2	CV	CV	CV	CV	CV	CV	CV	CV	CV	CV	CV	CV	CV	CV	CV	CV	CV	CV				
			MS = wire mesh 60 µm	MS	MS	MS	MS	MS	MS	MS	MS	MS	MS	MS	MS	MS	MS	MS	MS	MS	MS				
			SEALS																	SEALS					
			1 = NBR Nitrile	1	1	1	1	1	1	1	1	1	1	1	1	1	1	1	1	1	1				
			2 = FKM Fluoroelastomer	2	2	2	2	2	2	2	2	2	2	2	2	2	2	2	2	2	2				
			BYPASS VALVE																						
			B = 170 kPa (1,7 bar)	X	B	B	B	B	B	B	B	B	B	B	B	B	B	B	B	B	B				
			PORT TYPE																						
			B = BSP thread	B	B	B	B	B	B	B	B	B	B	B	B	B	B	B	B	B	B				
			N = NPT thread	N	N	N	N	N	N	N	N	N	N	N	N	N	N	N	N	N	N				
			S = SAE thread	S	S	S	S	S	S	S	S	S	S	S	S	S	S	S	S	S	S				
			F = SAE flange 3000 psi	-	-	-	-	-	-	-	-	-	-	-	-	-	-	F	F	F	F				
			PORT SIZE																						
			2 = 3/8"	2	-	-	-	-	-	-	-	-	-	-	-	-	-	-	-	-	-				
			3 = 1/2"	-	3	3	-	-	-	-	-	-	-	-	-	-	-	-	-	-	-				
			4 = 3/4"	-	-	-	4	4	-	-	-	-	-	-	-	-	-	-	-	-	-				
			5 = 1"	-	-	-	-	-	5	5	5	-	-	-	-	-	-	-	-	-	-				
			6 = 1" 1/4 (F6 not available)	-	-	-	-	-	-	-	-	6	6	6	-	-	-	-	-	-	-				
			7 = 1" 1/2	-	-	-	-	-	-	-	-	-	-	-	7	7	7	-	-	-	-				
			8 = 2" (F8 not available)	-	-	-	-	-	-	-	-	-	-	-	-	-	-	8	8	8	8				
			9 = 2" 1/2 (F9 only)	-	-	-	-	-	-	-	-	-	-	-	-	-	-	9	9	9	9				
			CLOGGING INDICATOR																						
			01 = 1/8" port, plugged	01	01	01	01	01	01	01	01	01	01	01	01	01	01	01	01	01	01				
			30 = pressure gauge, rear connection	30	30	30	30	30	30	30	30	30	30	30	30	30	30	30	30	30	30				
			32 = pressure gauge, cottom connection	32	32	32	32	32	32	32	32	32	32	32	32	32	32	32	32	32	32				
			P1 = SPDT pressure switch	P1	P1	P1	P1	P1	P1	P1	P1	P1	P1	P1	P1	P1	P1	P1	P1	P1	P1				
			ACCESSORIES																						
			S = without	S	S	S	S	S	S	S	S	S	S	S	S	S	S	S	S	S	S				
			T = with filling plug	T	T	T	T	T	T	T	T	T	T	T	T	T	T	T	T	T	T				
X			ACCESSORIES																						
			X= no other accessory available	X	X	X	X	X	X	X	X	X	X	X	X	X	X	X	X	X	X				

RFM

RETURN FILTERS



INSTALLATION DRAWING

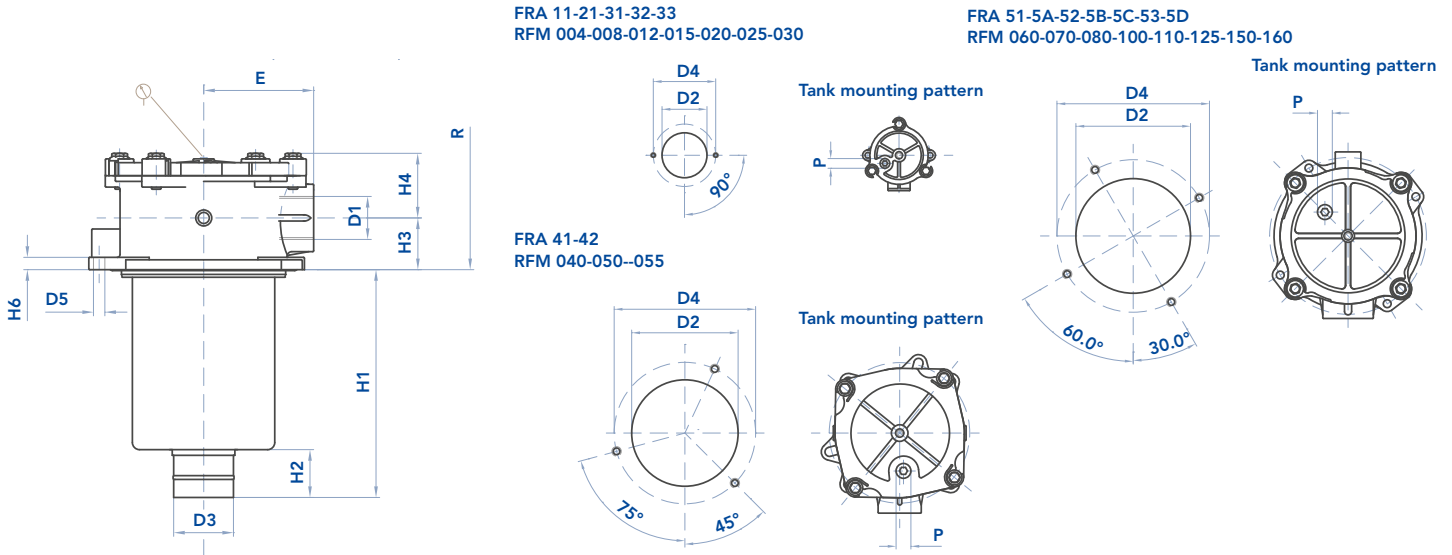

FILTER HOUSING

	D1	min D2	max D2	D3	D4	D5	E	H1	H2	H3	H4	H6	P	R	Kg
FRA11 RFM004	3/8"	50	50	12	80	6,5	40	59	16	12	33	9	1/8"	90	0,30
FRA21 RFM008	1/2"	67	68	24	90	6,5	50	80	20	22	33	9	3/8"	120	0,45
FRA31 RFM012-015	1/2"-3/4"	89	90	28	115	9	67	102	25	28	47	10	3/8"	150	0,80
FRA32 RFM020-025	3/4" - 1"	89	90	28	115	9	67	150	25	28	47	10	3/8"	190	0,95
FRA33 RFM030	3/4" - 1"	89	90	40	115	9	67	234	30	28	47	10	3/8"	270	1,10
FRA41 RFM040-050	1" - 1"1/4 - 1"1/2	126	131	40	175	10,5	95	248	50	35	56	13	1/2"	289	2,10
FRA42 RFM055	1" - 1"1/4 - 1"1/2	126	131	40	175	10,5	95	265	30	35	56	13	1/2"	306	2,30
FRA51 RFM060-070	1"1/4 - 1"1/2 - 2" - 2"1/2	174	180	50	220	10,5	115	178	50	55	69	13	1/2"	250	3,10
FRA5A RFM080	1"1/4 - 1"1/2 - 2" - 2"1/2	174	180	50	220	10,5	115	240	50	55	69	13	1/2"	315	3,50
FRA52 RFM100	1"1/4 - 1"1/2 - 2" - 2"1/2	174	180	63,5	220	10,5	115	240	50	55	69	13	1/2"	315	3,60
FRA5B RFM110	2" - 2"1/2	174	180	63,5	220	10,5	115	240	50	55	69	13	1/2"	315	3,65
FRA5C RFM125	2" - 2"1/2	174	180	63,5	220	10,5	115	240	50	55	69	13	1/2"	250	3,65
FRA53 RFM150	2" - 2"1/2	174	180	63,5	220	10,5	115	285	50	55	69	13	1/2"	355	4,10
FRA5D RFM160	2" - 2"1/2	174	180	63,5	220	10,5	115	300	50	55	69	13	1/2"	370	4,30

FRA-RFM

RETURN FILTERS



MAINTENANCE

The best time to change your filter element is just before it reaches its maximum dirt-holding capacity. For this reason, we recommend to monitor the pressure of the hydraulic oil flowing through the filter with a clogging indicator. When it is time to change the filter element, switch off the system before opening the filter housing. Unscrew the cover of the filter head and remove the spring (to be hold) and the dirty filter element. Replace it with an original UFI element, verifying the part number on the filter label or on the catalogue. Clean the bowl; check the gaskets conditions and replace if necessary. Insert the clean element and the spring into his seat, handling with care and cleanliness. Replace the cover on the filter head with the screw. We recommend the stocking of a spare UFI filter element for timely replacement when required.

FILTER ELEMENT

	A	B	C	Kg	AREA (cm ²)		
					Media F+	Media C+	Media M+
ERA11 CRE004	38	13	50	0,05	270	345	270
ERA21 CRE008	52	24	70	0,10	310	380	240
ERA31 CRE015	70	28	85	0,20	620	990	460
ERA32 CRE025	70	28	130	0,25	1.000	1.600	740
ERA33 CRE030	70	40	210	0,40	1.660	2.670	1.220
ERA41 CRE050	99	40	211	0,75	3.800	4.280	1.900
ERA42 CRE055	99	40	250	0,90	4.550	5.100	2.270
ERA51 CRE060	130	51	140	1,00	4.140	4.360	1.800
ERA5A CRE080	130	51	200	1,10	5.840	6.460	2.730
ERA52 CRE100	130	63	200	1,35	6.190	6.520	2.690
ERA5B CRE110	130	63	200	1,45	7.070	7.200	3.900
ERA5C CRE125	130	63	232	1,50	7.280	7.600	3.040
ERA53 CRE150	130	63	251	1,55	7.930	8.350	3.450
ERA5D CRE160	130	63	266	1,60	8.400	8.800	3.730

The used filter elements cannot be cleaned and are classified as "Dangerous waste material". They must be disposed according to local laws by authorized Companies. Verify that the Company you choose has the expertise and authorization to dispose this type of waste material.

PRESSURE DROP CURVES (Δp)

The "Assembly Pressure Drop (Δp)" is obtained by adding the pressure drop values of the Filter Housing and of the Clean Filter Element corresponding to the considered Flow Rate and it must

be lower than 50 kPa (0,5 bar) and should never exceed 1/3 of the bypass valve setting.

FILTER HOUSING PRESSURE DROP
(mainly depending on the port size)

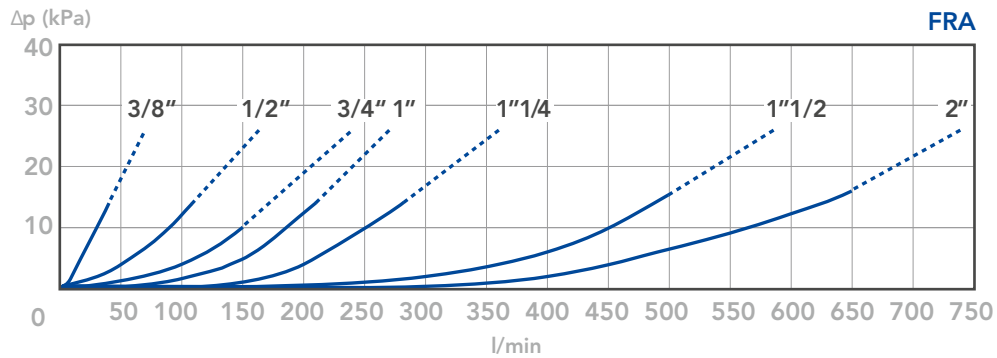

CLEAN FILTER ELEMENT PRESSURE DROP
(pressure drop values of the elements by ME - MF - MG media are very similar)

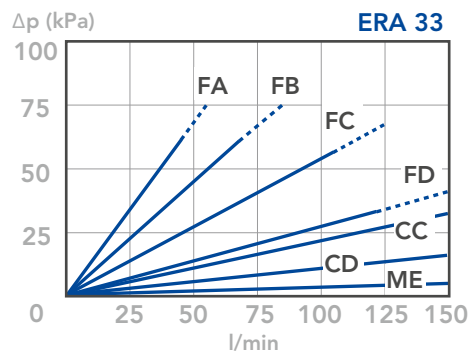
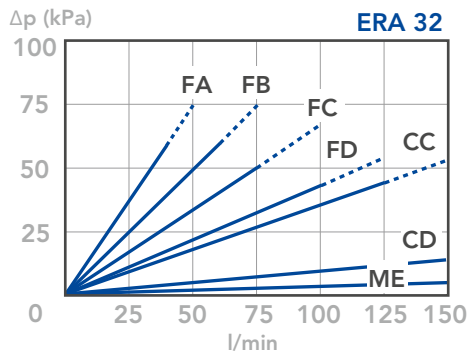
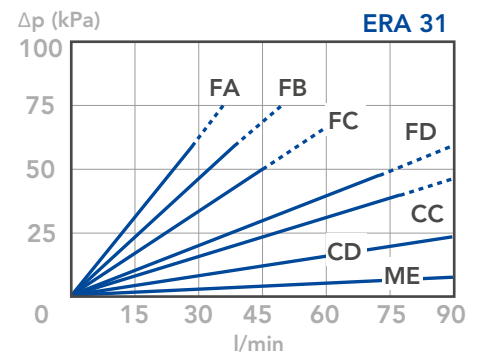
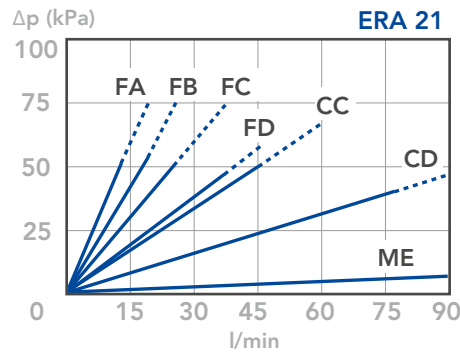
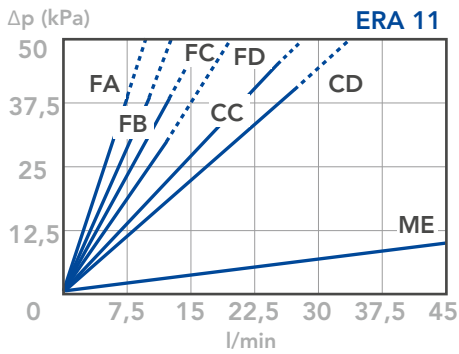

FRA-RFM

RETURN FILTERS



BYPASS VALVE PRESSURE DROP

When selecting the filter size, these curves must be taken into account if it is foreseen that any flow peak is to be absorbed by the bypass valve, it also must be of proper configuration to avoid pressure peaks. The valve pressure drop is directly proportional to fluid specific gravity.

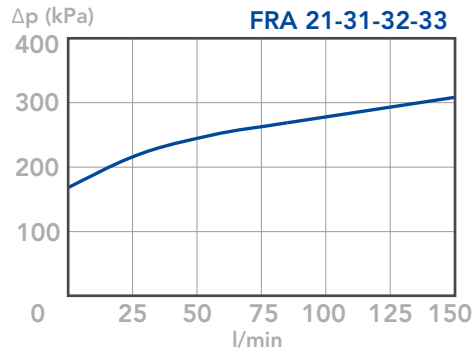

CLEAN FILTER ELEMENT PRESSURE DROP

(pressure drop values of the elements by ME - MF - MG media are very similar)

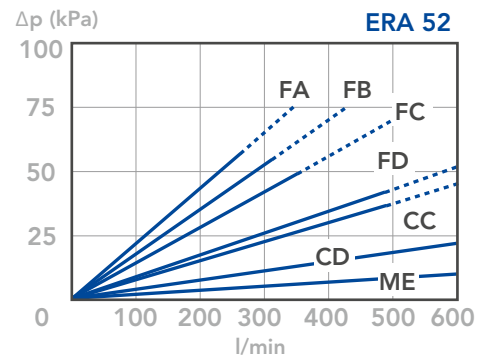
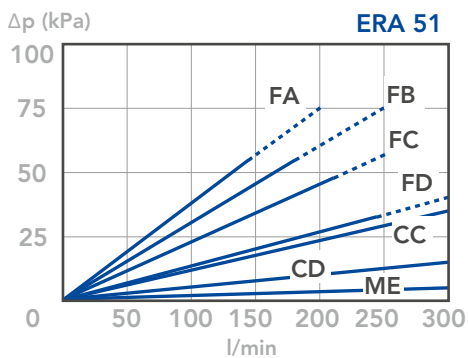
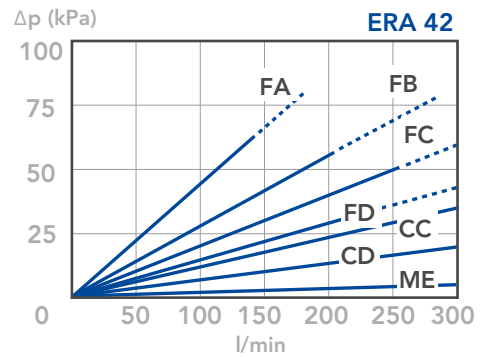
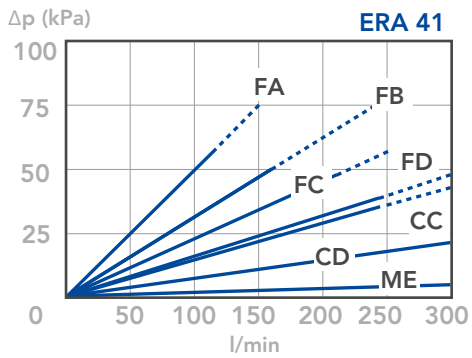

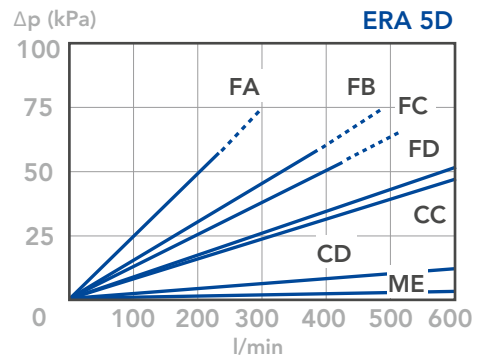
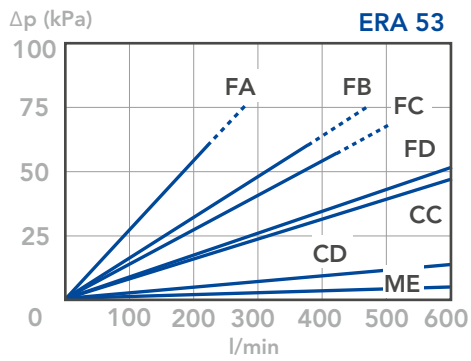

BYPASS VALVE PRESSURE DROP

When selecting the filter size, these curves must be taken into account if it is foreseen that any flow peak is to be absorbed by the bypass valve, it also must be of proper configuration to avoid pressure peaks. The valve pressure drop is directly proportional to fluid specific gravity.

