

FRG-RSC

RETURN FILTERS



MATERIALS

Diffusor: Zinc plated steel
Element support: Polyamide
(aluminium alloy for FRG3+ & FRG4+)
Magnetic core: Syntherized magnetic material
Seals: NBR Nitrile
(FKM Fluoroelastomer on request)

PRESSURE

Collapse, differential for the filter element (ISO 2941): 1 MPa (10 bar)

BYPASS VALVE

Setting: 170 kPa (1,7 bar) \pm 10%

WORKING TEMPERATURE

From -25° to +110° C

COMPATIBILITY (ISO 2943)

Full with fluids: HH-HL-HM-HV-HTG
(according to ISO 6743/4)
For fluids different than the above mentioned,
please contact our Customer Service.



HYDRAULIC DIAGRAM

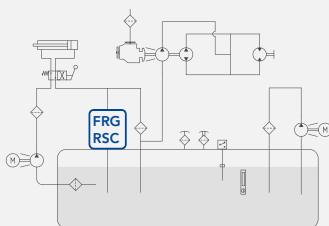

Is this datasheet the latest release? Please check on our website.



ORDERING AND OPTION CHART

F	R	G	COMPLETE FILTER FAMILY																	FILTER ELEMENT FAMILY	E	R	F
			SIZE & LENGTH	11	12	13	14	22	23	24	31	32	33	34	41	42	43	44	SIZE & LENGTH				
			T PORT TYPE																				
			T = in the tank	T	T	T	T	T	T	T	T	T	T	T	T	T	T	T	T	T	T	T	
			O PORT SIZE																				
			00	00	00	00	00	00	00	00	00	00	00	00	00	00	00	00	00	00	00	00	
			F BYPASS VALVE																				
			F = 170 kPa (1,7 bar)	F	F	F	F	F	F	F	F	F	F	F	F	F	F	F	F	F	F		
			SEALS																	SEALS			
			N = NBR Nitrile	N	N	N	N	N	N	N	N	N	N	N	N	N	N	N	N	N	N	N	
			F = FKM Fluoroelastomer	F	F	F	F	F	F	F	F	F	F	F	F	F	F	F	F	F	F		
			FILTER MEDIA																	FILTER MEDIA			
			FA = fibreglass 5 µm(c) β>1.000	FA	FA	FA	FA	FA	FA	FA	FA	FA	FA	FA	FA	FA	FA	FA	FA	FA	FA		
			FB = fibreglass 7 µm(c) β>1.000	FB	FB	FB	FB	FB	FB	FB	FB	FB	FB	FB	FB	FB	FB	FB	FB	FB	FB		
			FC = fibreglass 12 µm(c) β>1.000	FC	FC	FC	FC	FC	FC	FC	FC	FC	FC	FC	FC	FC	FC	FC	FC	FC	FC		
			FD = fibreglass 21 µm(c) β>1.000	FD	FD	FD	FD	FD	FD	FD	FD	FD	FD	FD	FD	FD	FD	FD	FD	FD	FD		
			CC = impregnated cellulose 10 µm β>2	CC	CC	CC	CC	CC	CC	CC	CC	CC	CC	CC	CC	CC	CC	CC	CC	CC	CC		
			ME = wire mesh 60 µm	ME	ME	ME	ME	ME	ME	ME	ME	ME	ME	ME	ME	ME	ME	ME	ME	ME	ME		
			X CLOGGING INDICATOR																				
			XX = not applicable	XX	XX	XX	XX	XX	XX	XX	XX	XX	XX	XX	XX	XX	XX	XX	XX	XX	XX		
			ACCESSORIES																				
			W = without diffusor	W	W	W	W	W	W	W	W	W	W	W	W	W	W	W	W	W	W		
			F = with diffusor	F	F	F	F	F	F	F	F	F	F	F	F	F	F	F	F	F	F		
			ACCESSORIES																				
			W = without magnetic core	W	W	W	W	W	W	W	W	W	W	W	W	W	W	W	W	W	W		
			M = with magnetic core	M	M	M	M	M	M	M	M	M	M	M	M	M	M	M	M	M	M		

SPARE PARTS ELEMENTS

FILTER HOUSING				FILTER ELEMENT				ACCESSORIES															
				<input type="checkbox"/>	<input type="checkbox"/>	<input type="checkbox"/>	<input type="checkbox"/>	<input type="checkbox"/>	<input type="checkbox"/>	<input type="checkbox"/>	<input type="checkbox"/>												
BRG	T	O	O	F																			



RSC RETURN FILTERS



ORDERING AND OPTION CHART

R	S	C	COMPLETE FILTER FAMILY																	FILTER ELEMENT FAMILY	C	R	C
			SIZE & LENGTH	110	120	130	140	220	230	240	310	320	330	340	410	420	430	440	SIZE & LENGTH				
			FILTER MEDIA																	FILTER MEDIA			
			FT = fibreglass 5 μm(c) β>1.000	FT	FT	FT	FT	FT	FT	FT	FT	FT	FT	FT	FT	FT	FT	FT	FT				
			FC = fibreglass 7 μm(c) β>1.000	FC	FC	FC	FC	FC	FC	FC	FC	FC	FC	FC	FC	FC	FC	FC	FC				
			FD = fibreglass 12 μm(c) β>1.000	FD	FD	FD	FD	FD	FD	FD	FD	FD	FD	FD	FD	FD	FD	FD	FD				
			FV = fibreglass 21 μm(c) β>1.000	FV	FV	FV	FV	FV	FV	FV	FV	FV	FV	FV	FV	FV	FV	FV	FV				
			CD = impregnated cellulose 10 μm β>2	CD	CD	CD	CD	CD	CD	CD	CD	CD	CD	CD	CD	CD	CD	CD	CD				
			MS = wire mesh 60 μm	MS	MS	MS	MS	MS	MS	MS	MS	MS	MS	MS	MS	MS	MS	MS	MS				
			SEALS																	SEALS			
			1 = NBR Nitrile	1	1	1	1	1	1	1	1	1	1	1	1	1	1	1	1				
			2 = FKM Fluoroelastomer	2	2	2	2	2	2	2	2	2	2	2	2	2	2	2	2				
		F	BYPASS VALVE																				
			F = 170 kPa (1,7 bar)	F	F	F	F	F	F	F	F	F	F	F	F	F	F	F	F				
XXXX			PORT TYPE / PORT SIZE INDICATORS																				
			XXXX = not available	XXXX	XXXX	XXXX	XXXX	XXXX	XXXX	XXXX	XXXX	XXXX	XXXX	XXXX	XXXX	XXXX	XXXX	XXXX	XXXX				
			ACCESSORIES																				
			S = without diffusor	S	S	S	S	S	S	S	S	S	S	S	S	S	S	S	S				
			D = with diffusor	D	D	D	D	D	D	D	D	D	D	D	D	D	D	D	D				
			ACCESSORIES																				
			S = without magnetic core	S	S	S	S	S	S	S	S	S	S	S	S	S	S	S	S				
			M = with magnetic core	M	M	M	M	M	M	M	M	M	M	M	M	M	M	M	M				

SPARE SEAL KIT

	NBR	FKM
FRG11 - RSC110	521.0063.2	521.0067.2
FRG12 - RSC120	521.0063.2	521.0067.2
FRG13 - RSC130	521.0063.2	521.0067.2
FRG14 - RSC140	521.0063.2	521.0067.2
FRG22 - RSC220	521.0064.2	521.0068.2
FRG23 - RSC230	521.0064.2	521.0068.2
FRG24 - RSC240	521.0064.2	521.0068.2
FRG31 - RSC310	521.0065.2	521.0069.2
FRG32 - RSC320	521.0065.2	521.0069.2
FRG33 - RSC330	521.0065.2	521.0069.2
FRG34 - RSC340	521.0065.2	521.0069.2
FRG41 - RSC410	521.0066.2	521.0070.2
FRG42 - RSC420	521.0066.2	521.0070.2
FRG43 - RSC430	521.0066.2	521.0070.2
FRG44 - RSC440	521.0066.2	521.0070.2

SPARE SPRING

FRG11 - RSC110	008.0282.1
FRG12 - RSC120	008.0282.1
FRG13 - RSC130	008.0282.1
FRG14 - RSC140	008.0282.1
FRG22 - RSC220	008.0269.1
FRG23 - RSC230	008.0269.1
FRG24 - RSC240	008.0269.1
FRG31 - RSC310	008.0275.1
FRG32 - RSC320	008.0275.1
FRG33 - RSC330	008.0275.1
FRG34 - RSC340	008.0275.1
FRG41 - RSC410	008.0283.1
FRG42 - RSC420	008.0283.1
FRG43 - RSC430	008.0283.1
FRG44 - RSC440	008.0283.1

FRG-RSC

RETURN FILTERS



INSTALLATION DRAWING

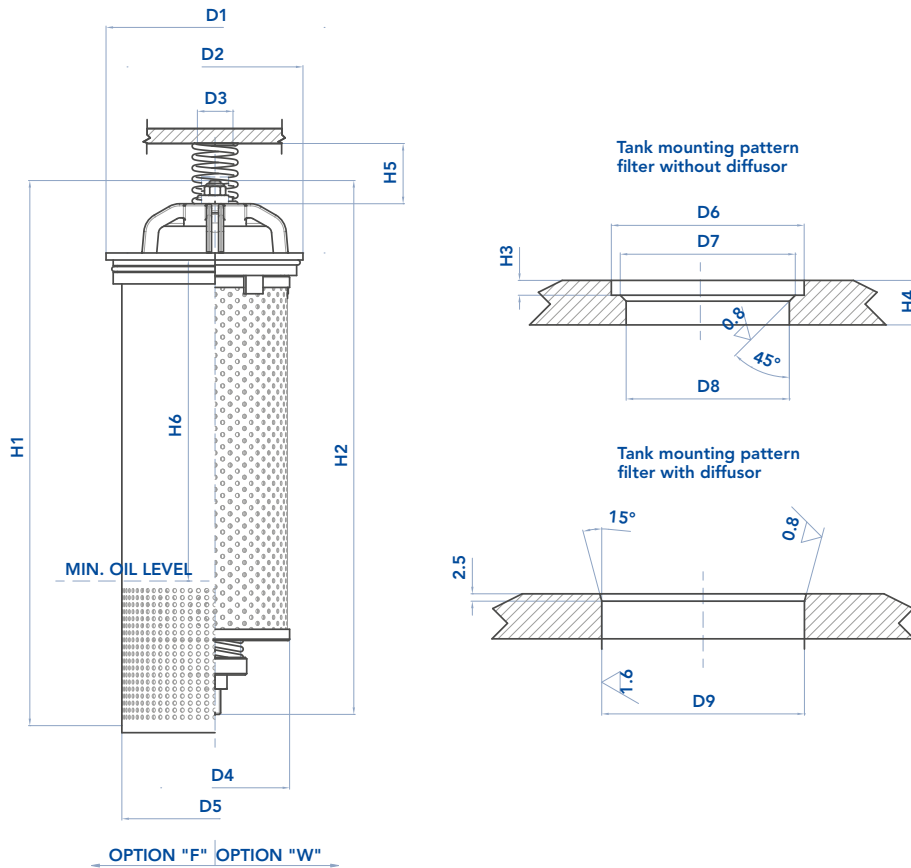

FILTER HOUSING

	D1	D2	D3	D4	D5	D6	D7	D8	D9	H1	H2	H3	H4	H5	H6	KG opz F	KG opz W
FRG11 - RSC110	120	87	20	72	89	88	82,5	76	110	245	180	4	12	45	118	1,25	0,70
RG12 - RSC120	120	87	20	72	89	88	82,5	76	110	245	224	4	12	45	118	1,45	0,90
FRG13 - RSC130	120	87	20	72	89	88	82,5	76	110	295	274	4	12	45	170	1,65	1,00
FRG14 - RSC140	120	87	20	72	89	88	82,5	76	110	395	374	4	12	45	270	2,10	1,30
FRG22 - RSC220	155	125,5	25	106	132	126	123,5	117	145	312	305	5	15	78	150	2,75	1,65
FRG23 - RSC230	155	125,5	25	106	132	126	123,5	117	145	382	375	5	15	78	220	3,20	1,90
FRG24 - RSC240	155	125,5	25	106	132	126	123,5	117	145	587	580	5	15	78	425	4,40	2,50
FRG31 - RSC310	185	150	25	126	165	151	149	139	178	365	351	5	18	100	190	3,85	2,25
FRG32 - RSC320	185	150	25	126	165	151	149	139	178	455	431	5	18	100	270	4,70	2,80
FRG33 - RSC330	185	150	25	126	165	151	149	139	178	555	531	5	18	100	370	5,60	3,20
FRG34 - RSC340	185	150	25	126	165	151	149	139	178	645	619	5	18	100	460	6,20	3,50
FRG41 - RSC410	260	230	40	203	235	231	227	217	250,5	530,5	515	6	20	140	205	10,20	7,20
FRG42 - RSC420	260	230	40	203	235	231	227	217	250,5	745,5	730	6	20	140	420	14,00	9,50
FRG43 - RSC430	260	230	40	203	235	231	227	217	250,5	1025,5	1010	6	20	140	700	20,00	14,00
FRG44 - RSC440	260	230	40	203	235	231	227	217	250,5	1290,5	1275	6	20	140	965	26,00	19,00

MAINTENANCE

The best time to change your filter element is just before it reaches its maximum dirt-holding capacity. For this reason, we recommend to monitor the pressure of the hydraulic oil flowing through the filter with a clogging indicator. When it is time to change the filter element, switch off the system. Remove the complete filter by upper handle and if necessary remove the spring. Unscrew the nut from tie-rod and remove the spring holder and the spring. Remove dirty filter element. If the magnetic core is present on the tie rod, clean it carefully. Replace

it with an original UFI element, verifying the part number on the filter label or on the catalogue. Lubricate the new element O-Ring gasket with oil. Insert the clean element on tie-rod handling with care and cleanliness. Assemble the spring, spring holder and tighten the nut on the tie-rod until it stops, with a tightening torque of 15 Nm +3/0. Insert the complete filter into the seat.

We recommend the stocking of a spare UFI filter element for timely replacement when required.

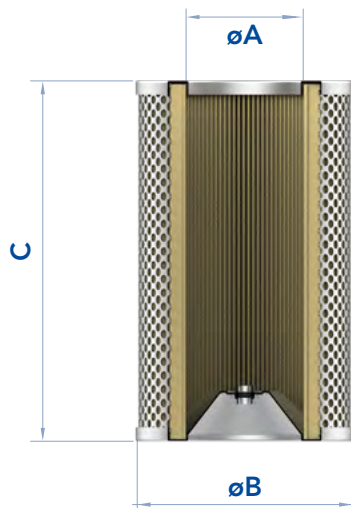

FILTER ELEMENT

	A	B	C	Kg	AREA (cm ²)		
					Media F+	MediaH+	Media C+
ERF11 - CRC110	45	72	106	0,25	770	1.250	460
ERF12 - CRC120	45	72	150	0,35	1.170	1.800	650
ERF13 - CRC130	45	72	200	0,45	1.570	2.450	880
ERF14 - CRC140	45	72	300	0,60	2.370	3.600	1.320
ERF22 - CRC220	72	106	190	0,75	3.900	4.600	1.500
ERF23 - CRC230	72	106	260	1,00	5.400	6.400	2.050
ERF24 - CRC240	72	106	465	1,50	9.700	11.800	3.670
ERF31 - CRC310	92	126	210	1,15	5.500	6.650	2.250
ERF32 - CRC320	92	126	290	1,50	7.700	9.200	3.150
ERF33 - CRC330	92	126	390	1,90	10.400	12.400	4.250
ERF34 - CRC340	92	126	480	2,20	12.800	15.400	5.250
ERF41 - CRC410	157	203	330	3,90	17.900	22.100	6.400
ERF42 - CRC420	157	203	545	5,20	30.000	37.000	10.800
ERF43 - CRC430	157	203	825	9,00	45.200	55.500	16.200
ERF44 - CRC440	157	203	1.090	13,00	60.000	74.000	21.800

The used filter elements cannot be cleaned and are classified as "Dangerous waste material". They must be disposed according to local laws by authorized Companies.

Verify that the Company you choose has the expertise and authorization to dispose this type of waste material.

FRG-RSC

RETURN FILTERS



PRESSURE DROP CURVES (Δp)

The “Assembly Pressure Drop (Δp)” is obtained by adding the pressure drop values of the Filter Housing and of the Clean Filter Element corresponding to the considered Flow Rate and it must be lower than 50 kPa (0,5 bar) and should never exceed 1/3 of the bypass valve setting.

CLEAN FILTER ELEMENT PRESSURE DROP WITH F+, C+ AND ME MEDIA (depending both on the internal diameter of the element and on the filter media)

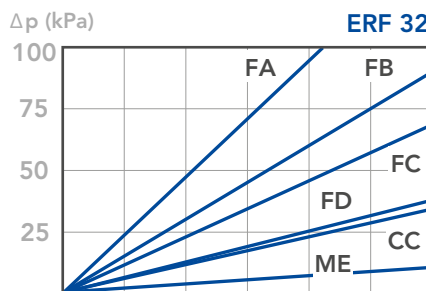
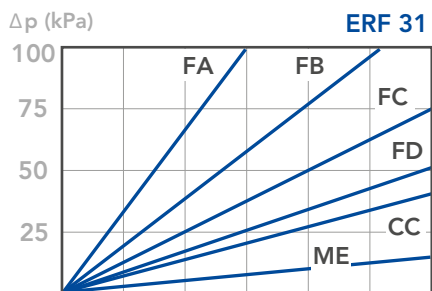
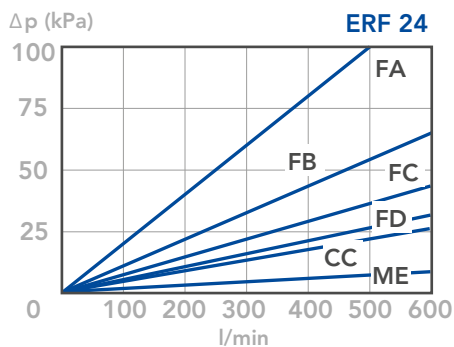
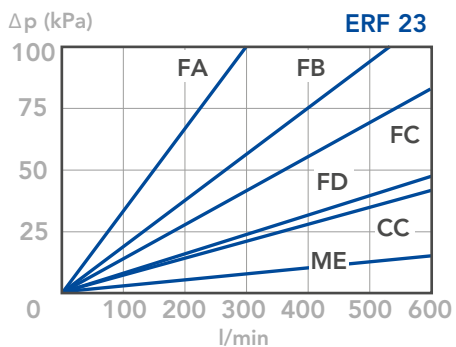
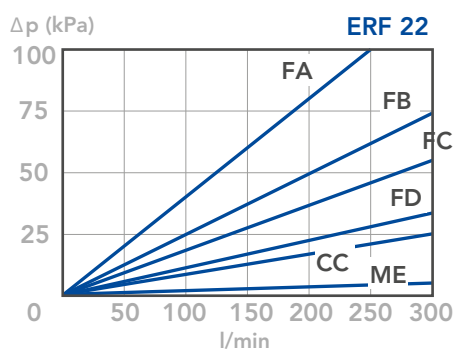
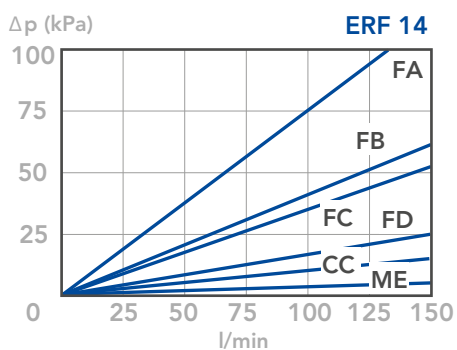
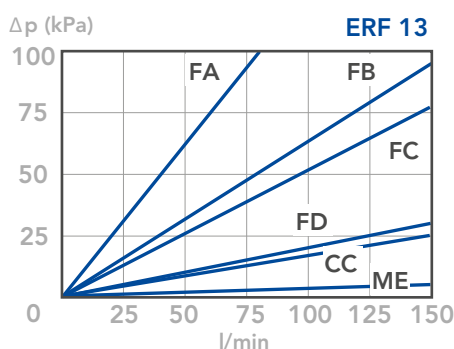
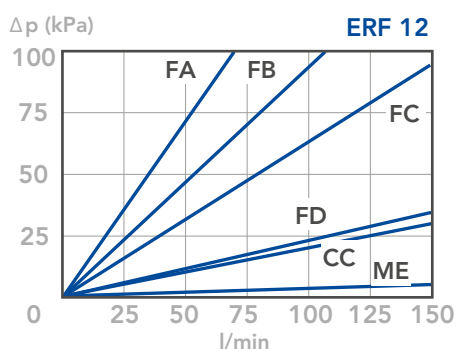
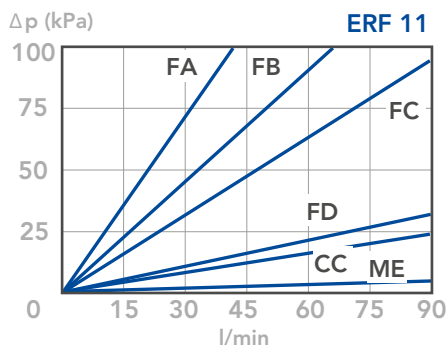

CLEAN FILTER ELEMENT PRESSURE DROP WITH F+, C+ AND ME MEDIA
(depending both on the internal diameter of the element and on the filter media)

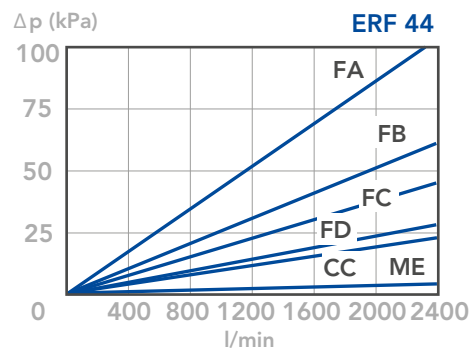
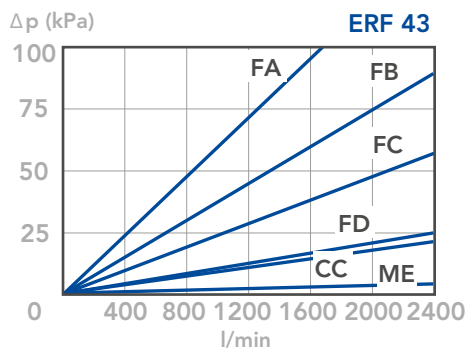
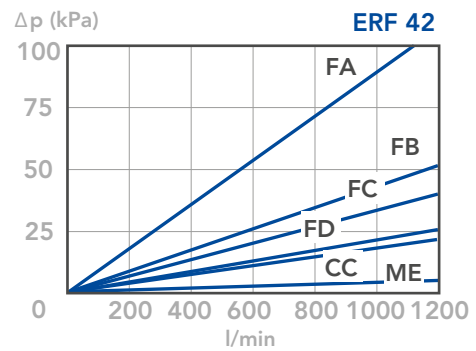
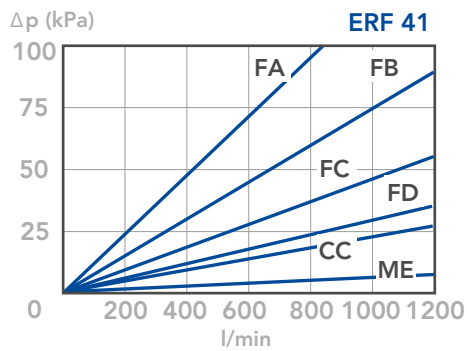
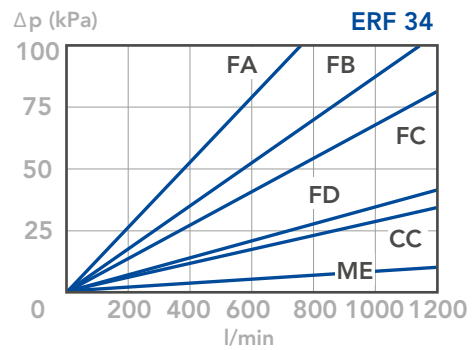
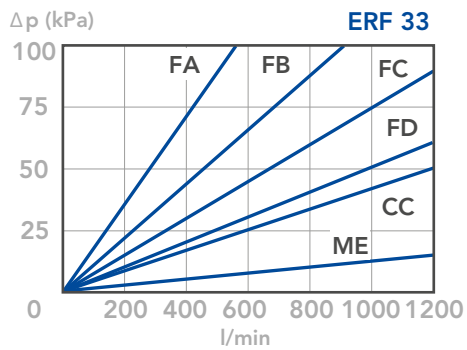

N.B.

All the curves have been obtained with mineral oil having a kinematic viscosity 30 cSt and specific gravity 0,86 Kg/dm³; for fluids with different features, please consider the factors described in the first part of this catalogue. All the curves

are obtained from test done at the UFI HYDRAULIC DIVISION Laboratory, according to the specification ISO 3968. In case of discrepancy, please check the contamination level, viscosity and features of the fluid in use.

FRG-RSC

RETURN FILTERS



BYPASS VALVE PRESSURE DROP

When selecting the filter size, these curves must be taken into account if it is foreseen that any flow peak is to be absorbed by the bypass valve, it also must be of proper configuration to avoid pressure peaks. The valve pressure drop is directly proportional to fluid specific gravity.

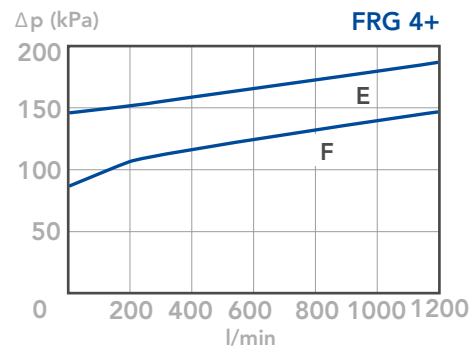
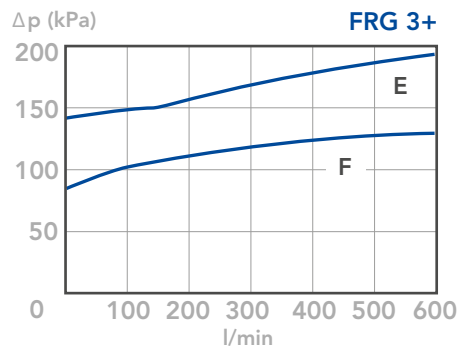
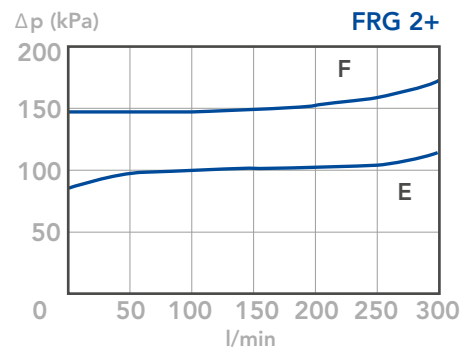
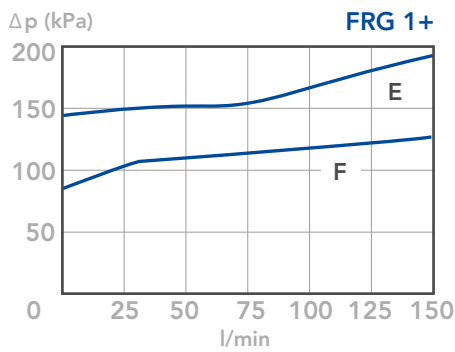

N.B.

All the curves have been obtained with mineral oil having a kinematic viscosity 30 cSt and specific gravity 0,86 Kg/dm³; for fluids with different features, please consider the factors described in the first part of this catalogue. All the curves

are obtained from test done at the UFI HYDRAULIC DIVISION Laboratory, according to the specification ISO 3968. In case of discrepancy, please check the contamination level, viscosity and features of the fluid in use.